

Linea **implantare**

Catalogo

EasySlim

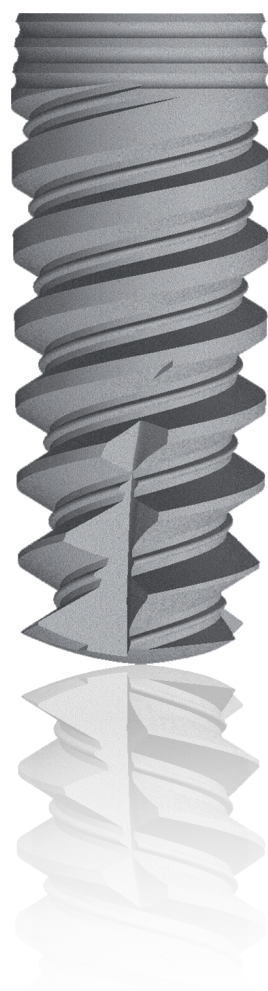

Contenuti

L'impianto Easy Slim	
La gamma	4
Gli stop fresa	6
Il tray chirurgico	7
Descrizione protesiche	
La guarigione	8
L'impronta	8
Componenti protesiche	9
Overdenture	11
Monconi angolati M.U.A.	12
Viti di serraggio	14

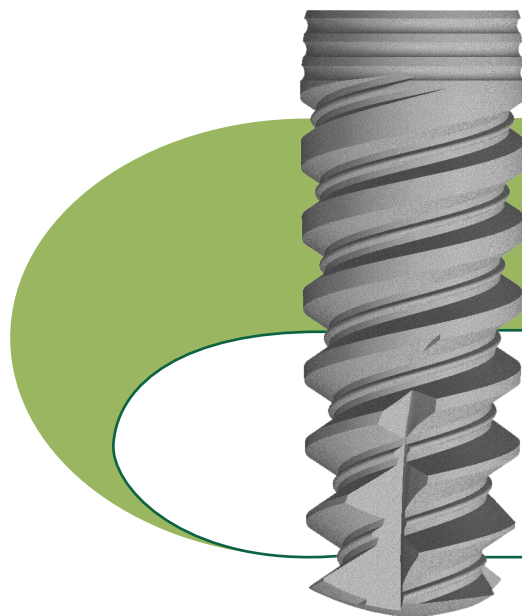

Easy**Slim**

La gamma

Impianto

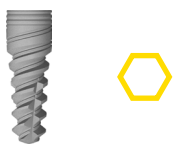
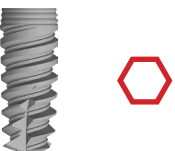
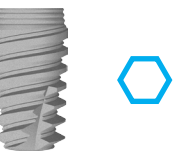
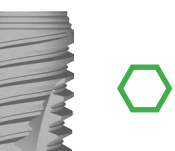
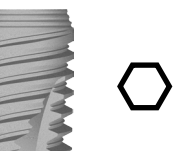
	Lunghezza	Codice Art.	Misure			
			A	B	C	D
 Impianto Ø 3.3	10 mm	1033ES	Ø 3.8	Ø 3.1	Ø 1.85	Ø 3.5
	11.5 mm	1133ES	Ø 3.8	Ø 3.0	Ø 1.70	Ø 3.5
	13 mm	1333ES	Ø 3.8	Ø 2.95	Ø 1.55	Ø 3.5
	16 mm	1633ES	Ø 3.8	Ø 2.85	Ø 1.25	Ø 3.5
 Impianto Ø 3.8	8 mm	0838ES	Ø 3.9	Ø 3.0	Ø 2.60	Ø 3.5
	10 mm	1038ES	Ø 3.9	Ø 3.70	Ø 2.35	Ø 3.5
	11.5 mm	1138ES	Ø 3.9	Ø 3.60	Ø 2.20	Ø 3.5
	13 mm	1338ES	Ø 3.9	Ø 3.50	Ø 2.05	Ø 3.5
	16 mm	1638ES	Ø 3.9	Ø 3.40	Ø 1.95	Ø 3.5
 Impianto Ø 4.2	6 mm	0642ES	Ø 4.3	Ø 4.25	Ø 3.10	Ø 3.5
	8 mm	0842ES	Ø 4.3	Ø 4.15	Ø 2.85	Ø 3.5
	10 mm	1042ES	Ø 4.3	Ø 4.05	Ø 2.65	Ø 3.5
	11.5 mm	1142ES	Ø 4.3	Ø 4.00	Ø 2.50	Ø 3.5
	13 mm	1342ES	Ø 4.3	Ø 3.90	Ø 2.35	Ø 3.5
	16 mm	1642ES	Ø 4.3	Ø 3.80	Ø 2.05	Ø 3.5
 Impianto Ø 5.0	6 mm	0650ES	Ø 5.0	Ø 4.95	Ø 3.90	Ø 3.5
	8 mm	0850ES	Ø 5.0	Ø 4.85	Ø 3.65	Ø 3.5
	10 mm	1050ES	Ø 5.0	Ø 4.75	Ø 3.45	Ø 3.5
	11.5 mm	1150ES	Ø 5.0	Ø 4.70	Ø 3.30	Ø 3.5
	13 mm	1350ES	Ø 5.0	Ø 4.65	Ø 3.15	Ø 3.5
	16 mm	1650ES	Ø 5.0	Ø 4.54	Ø 2.80	Ø 3.5
 Impianto Ø 6.0	6 mm	0660ES	Ø 6.0	Ø 5.95	Ø 4.90	Ø 3.5
	8 mm	0860ES	Ø 6.0	Ø 5.85	Ø 4.65	Ø 3.5
	10 mm	1060ES	Ø 6.0	Ø 5.75	Ø 4.45	Ø 3.5
	11.5 mm	1160ES	Ø 6.0	Ø 5.70	Ø 4.30	Ø 3.5
	13 mm	1360ES	Ø 6.0	Ø 5.65	Ø 4.15	Ø 3.5
	16 mm	1660ES	Ø 6.0	Ø 5.54	Ø 3.80	Ø 3.5

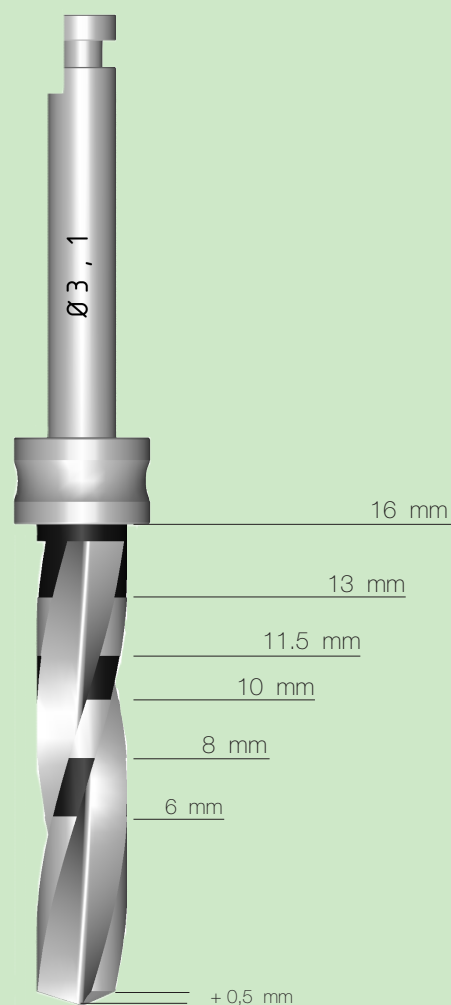
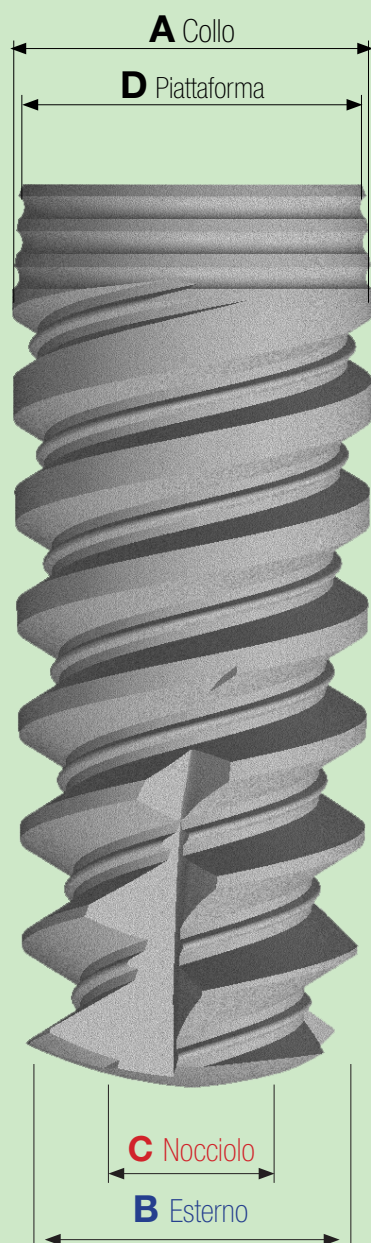

VITE TAPPO



Costruita in titanio Gr.5 è prevista in ogni confezione di impianto.
Utilizzabile manualmente con il driver (es. 1,3 mm. chiusura consigliata Torque 15/20 Ncm.)

Glistopfresa

Gli stop per la fresa Ø 2,0-Ø 2,9

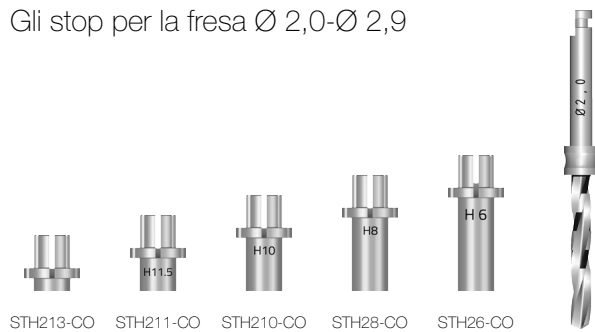

STH213-CO STH211-CO STH210-CO STH28-CO STH26-CO

Gli stop per la fresa Ø 3,1-Ø 3,9

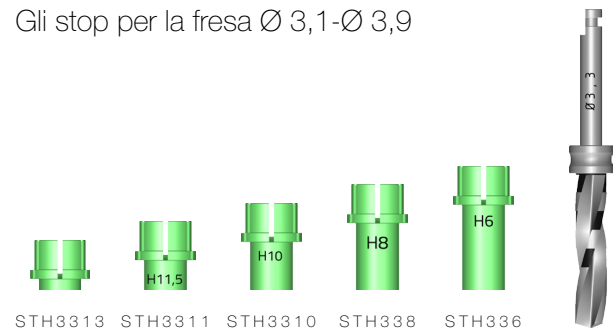

STH3313 STH3311 STH3310 STH338 STH336

Gli stop per la fresa Ø 4,0-Ø 4,9



STH4213 STH4211 STH4210 STH428 STH426

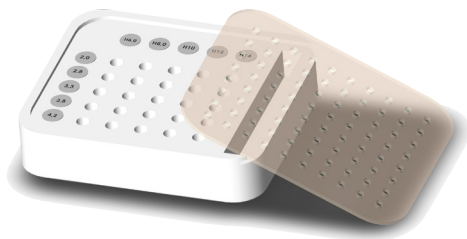











KIT-STES

Codice	Descrizione
KIT-STES	Box stop completo
	Box stop vuoto
	Stop singoli

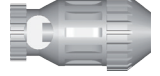

Codice	Descrizione
K02ES	Box standard vuoto
MNK02ES	Mini box vuoto

Iltraychirurgico

	Dimensione	Codice Art.	Box	
			Mini Box	Standard
 Lanceolata	-	1033ES	SI	SI
 Prolunga	-	EDCOLL01	SI	SI
 Frese cilindriche	Ø 2.0 L16	TDCO216S	SI	SI
	Ø 2.8 L16	TDCO2816S	SI	SI
	Ø 3.2 L16	TDCO3216S	SI	SI
	Ø 3.7 L16	TDCO3716S	SI	SI
	Ø 4.1 L16	TDCO4116S	SI	SI
	Ø 4.9 L16	TDCO4916S	SI	SI
	Ø 5.9 L16	TDCO5916S	NO	SI
 Avvitorie viti	Es 1.3 L 9	MNCO13S	NO	SI
	Es 1.3 L 10	MNCO13M	SI	NO
	Es 1.3 L 13	MNCO13L	NO	SI
 Avvitatore impianto	Es 2.4 L 8	WMNES24S	NO	SI
	Es 2.4 L 11	WMNES24S	SI	NO
	Es 2.4 L 16	WMNES24S	NO	SI
 Driver viti	Es 1.3 L 13	DRC013S	NO	SI
	Es 1.3 L 17	DRC013M	SI	NO
	Es 1.3 L 23	DRC013L	NO	SI
 Driver impianto	Es 2.4 L 13	DRES24S	NO	SI
	Es 2.4 L 17	DRES24M	SI	NO
	Es 2.4 L 23	DRES24L	NO	SI
 Indicatori	Ø 2.0-Ø 2.7	PRCO01	NO	SI
	Ø 3.2-Ø 3.7	PRCO02	NO	SI
 Adattatore	-	ADWHK01	NO	SI
 Chiave	15-35 Ncm	CRIC01	NO	SI
	25-55 Ncm	CRIC02	NO	NO
	Rigida	CRIC03	SI	NO

La guarigione

Healing Abutment

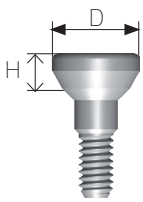
	Codice Art.	Dimensione H	Dimensione D
	VGS2ES	2.0 mm	Ø 3.8 mm
	VGS3ES	3.0 mm	Ø 3.8 mm
	VGS4ES	4.0 mm	Ø 3.8 mm
	VGS5ES	5.0 mm	Ø 3.8 mm
	VGS42ES	2.0 mm	Ø 4.7 mm
	VGS43ES	3.0 mm	Ø 4.7 mm
	VGS44ES	4.0 mm	Ø 4.7 mm
	VGS45ES	5.0 mm	Ø 4.7 mm

L'impronta

Transfer da impronta

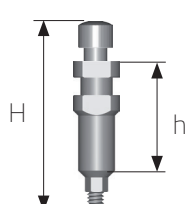

	Codice Art.	Dimensione h	Dimensione H
	TRA11ES	9,5 mm	18 mm
	TRA16ES	13,5 mm	22 mm
<p>La confezione prevede la vite di serraggio Vite associata TRA16ES Codice : VSTRA16ES</p>			

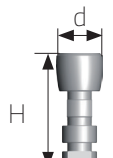
Analogo da gesso

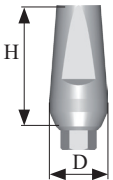

	Codice Art.	Dimensione H	Dimensione d
	ANA16ES	12mm	Ø 3,75 mm

Le componenti protesiche

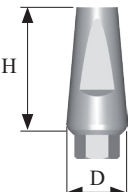

Monconi dritti

Moncone stretto	Codice Art.	Dimensione H	Emergenza D
	CTP16ES	9 mm	Ø 3.75 mm
		Vite associata Codice : VS7818ES	

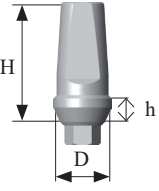

Monconi dritti

Moncone a finire	Codice Art.	Dimensione H	Emergenza D
	MAC16ES	11.5 mm	Ø 4.8 mm
	WMAC16ES	11.5 mm	Ø 6 mm
		Vite associata Codice : VS7818ES	

Monconi dritti

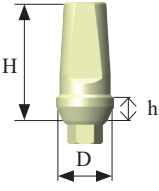

Moncone a spalla	Codice Art.	Dimensione H	Dimensione h	Emergenza D
	0020ES	9.5 mm	2mm	Ø 5.5 mm
	0040ES	11.5 mm	4mm	Ø 5.5 mm
		Vite associata Codice : VS7818ES		

Moncone provvisorio

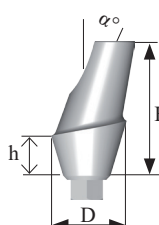

Provvisorio PeeK	Codice Art.	Dimensione H	Dimensione h	Emergenza D
	PEEKES	11.5 mm	4 mm	Ø 5.5 mm
		Vite associata Codice : VS7818ES		

Le componenti protesiche

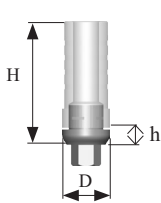

Monconi angolati

Moncone Angolato	Codice Art.	Angolo a°	Dimens. H	Dimen. h	Emerg. D
	AN151ES	15	9 mm	1 mm	Ø 5 mm
	AN153ES	15	11 mm	3 mm	Ø 5 mm
	AN251ES	25	9 mm	1 mm	Ø 5 mm
	AN253ES	25	11 mm	3 mm	Ø 5 mm
		Vite associata Codice : VS7818ES			

Moncone calcinabile con base Au

Cilindro - base Au	Codice Art.	Dimens. H	Dimens. h	Emergenza D
	CON16ES	9.8 mm	2 mm	Ø 5.6 mm
		Vite associata Codice : VS7818ES		

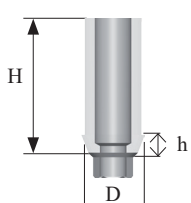
Moncone calcinabile



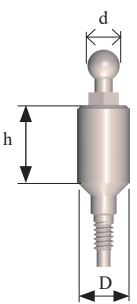

Calcinabile	Codice Art.	ES	Dimens. H	Dimens. h	Emerg. D
	CCR16ES	NO	13.5 mm	2.5 mm	Ø 4.5 mm
	CCN16ES	SI	13.5 mm	2.5 mm	Ø 4.5 mm
		Vite associata Codice : VS7818ES			

Overdenture



Overdenture

Ball Abutment	Codice Art.	Dimensione h	Diametro d	Emergenza D
	BALLO1ES	1 mm	2.5 mm	Ø4 mm
	BALLO2ES	2 mm	2.5 mm	Ø4 mm
	BALLO3ES	3 mm	2.5 mm	Ø4 mm
	BALLO4ES	4 mm	2.5 mm	Ø4 mm
	BALLO5ES	5 mm	2.5 mm	Ø4 mm

Ricambi overdenture RHEIN

Descrizione	Aspetto	Codice Art.	Dimensione H	Diametro D	Prezzo
Guaine		CA001	3.2 mm	Ø 4 mm	(6 pz) € 26
		CN001	3.2 mm	Ø 4 mm	(6 pz) € 26
		CN002	3.2 mm	Ø 4 mm	(6 pz) € 26
Contenitore		CAOES01	3.2 mm	Ø 5.5 mm	(2 pz) € 27

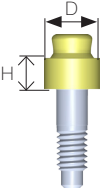
OT Equator RHEIN

Abutment OT	Codice Art.	Dimensione H	Diametro D	
	OT0005ES	0.5 mm	Ø 3.5mm	
	OT001ES	1 mm	Ø 3.5mm	
	OT002ES	2 mm	Ø 3.5mm	
Composizione Confezione	OT003ES	3 mm	Ø 3.5mm	
	OT004ES	4 mm	Ø 3.5mm	
	OT005ES	5 mm	Ø 3.5mm	
	OT006ES	6 mm	Ø 3.5mm	
	OT007ES	7 mm	Ø 3.5mm	
			Codice accessorio : OTAVES (optional)	



Overdenture

Ricambi OT Equator

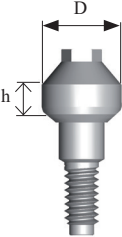

Descrizione		Codice Art.	Descrizione	Prezzo
Contenitore per guaina		C12ES	Contenitore	(2 pz) € 20
Guaine		CBST4ES	Tenuta standard (1.8 Kg)	(4 pz) € 28
		CRS4ES	Tenuta soft (1.2 Kg)	(4 pz) € 28
		CGE4ES	Tenuta extra soft (0.6 Kg)	(4 pz) € 28
		CVF4ES	Tenuta Forte (2.7 Kg)	(4 pz) € 28
		CNL4ES	Da laboratorio	(4 pz) € 28

Monconi M.U.A

Monconi M.U.A angolati 0°

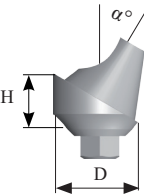

Moconi Diritti	Codice Art.	Dimensione h	Emergenza D
	MU01ES	1 mm	Ø 5 mm
	MU02ES	2 mm	Ø 5 mm
	MU03ES	3 mm	Ø 5 mm
	MU04ES	4 mm	Ø 5 mm
		Accessorio Codice : MUAVES	

Monconi M.U.A angolati 17°- 30°

Monconi Angolati	Codice Art.	Angolo a°	Dimensione H	Diametro D
	MU17ES	17°	3 mm	Ø 5mm
	MU30ES	30°	3 mm	Ø 5mm
		Vite associata Codice : VSM6918ES		

Monconi M.U.A

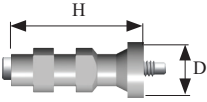
Impronta M.U.A angolati 0° . 17° . 30°

Transfer da Impronta	Codice Art.	Dimensione H	Diametro D
	TRAMUES	10.5 mm	Ø 5 mm
		Vite associata Codice : VSTNMES	

Analogo M.U.A angolati 0° . 17° . 30°

€ 40 cad 1 + iva

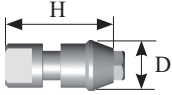
Analogo	Codice Art.	Dimensione H	Diametro
	ANAMUES	13 mm	Ø 5 mm

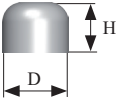

Guarigione M.U.A

€ 25 cad 1 + iva

Vite guarigione Ti	Codice Art.	Dimensione H	Diametro D
	VGSMUES	4.5 mm	Ø 5 mm

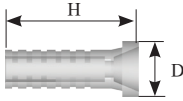

Monconi Calcinabili M.U.A

€ 40 cad 1 + iva

Moncone Calcinabile	Codice Art.	Dimensione H	Diametro
	MUCCES	12.3 mm	Ø 5 mm
		Vite associata Codice : VSC3414ES	



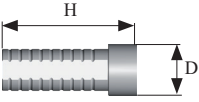

Monconi Ti M.U.A

€ 45 cad 1 + iva

Moncone Titanio	Codice Art.	Dimensione H	Diametro
	MUMTES	12.3 mm	Ø 5mm
		Vite associata Codice : VSC3414ES	

Viti serraggio

Viti per protesi

Per monconi standard	Per monconi angolati 17° 30°	Per Pick Up	Protesi su MUA	Per pick up MUA
 <p>— Es 1,3 mm — M 1,8</p>	 <p>— Es 1,3 mm — M 1,8</p>	 <p>— Es 1,3 mm — M 1,8</p>	 <p>— Es 1,3 mm — M 1,4</p>	 <p>— Es 1,3 mm — M 1,4</p>
VS7818ES VS7818ESL (L = LABORATORIO)	VSM6918ES	VSTRA11ES VSTRA16ES	VSC3414ES	VSTNMES

NOTE:

A series of horizontal dotted lines for writing notes.



Ornaghi Luigi & C. s.n.c.
Via S. Margherita, 121 - 20861 Brugherio (MB)
Tel +39 0392142070
www.ornaghiluiigi.com

La Ornaghi L si riserva di apportare modifiche senza preavviso. EASY_SLIM_CATALOGO_23_09_2020_rev00